



Sigma Power Systems

SG12350FP (12V 35.0Ah)

This product is a general purpose rechargeable battery Sealed Lead Acid (SLA) Technology. It is also called Valve Regulated Lead Acid (VRLA) battery. The design life is 5 years at 25 C (77°F) when used under normal operating conditions. Higher temperatures, higher charging voltage, storing at lower state of charge are some of the factors affect the life of the SLA battery. Capacity will vary depending on the temperature. Check the graphs below for details. Always follow the safety instructions while handling the battery.

Specification

Cells per Unit	6
Nominal Voltage per cell/battery	2/12 V
Capacity	35.0 Ah at 20 hr.-rate to 1.75V per cell at 25° C
Weight	Approximately 10.50 KG/23.14 lbs. (Tolerance ± 3%)
Maximum Charge Current	10.5 A
Operating Temperature Range	Discharge: -20°C ~ 60°C Charge: 0°C ~ 50°C Storage: -20°C ~ 60°C
Nominal Operating Temperature Range	25 ± 5°C
Float Charge Voltage	13.6 to 13.8 VDC/unit Average at 25°C
Maximum Discharging Current Limit	350 Amp (5 seconds)



Equalization and Cycle Service	14.6 to 14.8 VDC/unit Average at 25°C
Self Discharge	Self-discharge ratio less than 3% per month at 25°C. Please charge batteries before using.
Terminals	F7/F11
Jar Material	A.B.S UL94-HB

Physical Dimensions: in (mm)

Dimensions

Unit: mm Dimension: 195(L)×130(W)×180(H)

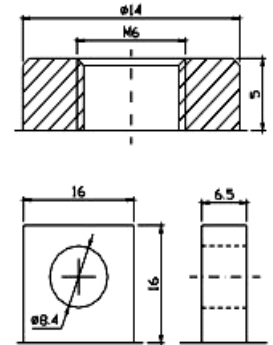
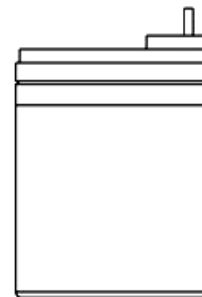
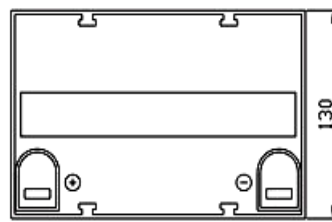
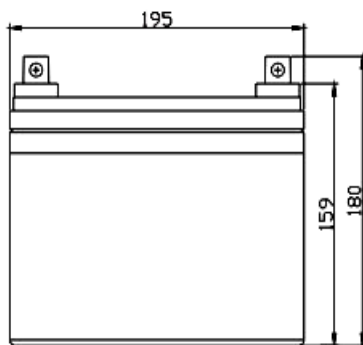



Sigma Power Systems

SG12350FP (12V 35.0Ah)

Use this chart to estimate the current for various times and end of discharge of voltages (EDV)

Constant Current Discharge Characteristics: Amp (25°C)

EDV	5 Min.	10 Min.	15 Min.	30 Min.	1 Hr.	2 Hr.	3 Hr.	5 Hr.	8 Hr.	10 Hr.	20 Hr.
9.60 V	110.6	81.41	63.46	38.67	21.45	12.83	8.858	6.178	4.220	3.500	1.868
10.0 V	107.4	77.46	62.16	38.01	21.35	12.73	8.824	6.141	4.185	3.466	1.834
10.2 V	104.2	74.73	61.18	37.20	21.15	12.63	8.756	6.105	4.151	3.433	1.800
10.5 V	93.56	68.95	58.26	37.02	20.96	12.54	8.722	6.032	4.117	3.399	1.766
10.8 V	84.45	62.88	53.70	36.39	20.46	12.31	8.485	5.923	4.048	3.365	1.732
11.1 V	72.10	56.20	48.17	34.07	19.44	11.77	8.111	5.669	3.877	3.264	1.630

Use this chart to estimate the power for various times and end of discharge voltages (EDV)

Constant Power Discharge Characteristics: Watt (25°C)

EDV	5 Min.	10 Min.	15 Min.	30 Min.	1 Hr.	2 Hr.	3 Hr.	5 Hr.	8 Hr.	10 Hr.	20 Hr.
9.60 V	1167.0	867.0	691.8	434.0	247.9	151.2	105.41	73.70	50.38	41.82	22.39
10.0 V	1144.0	840.4	680.7	428.7	247.3	150.4	105.45	73.51	50.14	41.56	22.00
10.2 V	1130.0	818.2	673.1	425.6	245.4	149.5	104.99	73.26	49.81	41.19	21.60
10.5 V	1029.0	761.9	642.0	422.7	243.2	148.4	104.58	72.39	49.40	40.79	21.19
10.8 V	937.4	702.4	593.4	415.9	238.7	146.5	101.73	71.08	48.58	40.38	20.78
11.1 V	823.3	635.0	534.2	391.7	228.5	141.1	97.34	68.03	46.52	39.17	19.56

Temperature and Valid Capacity

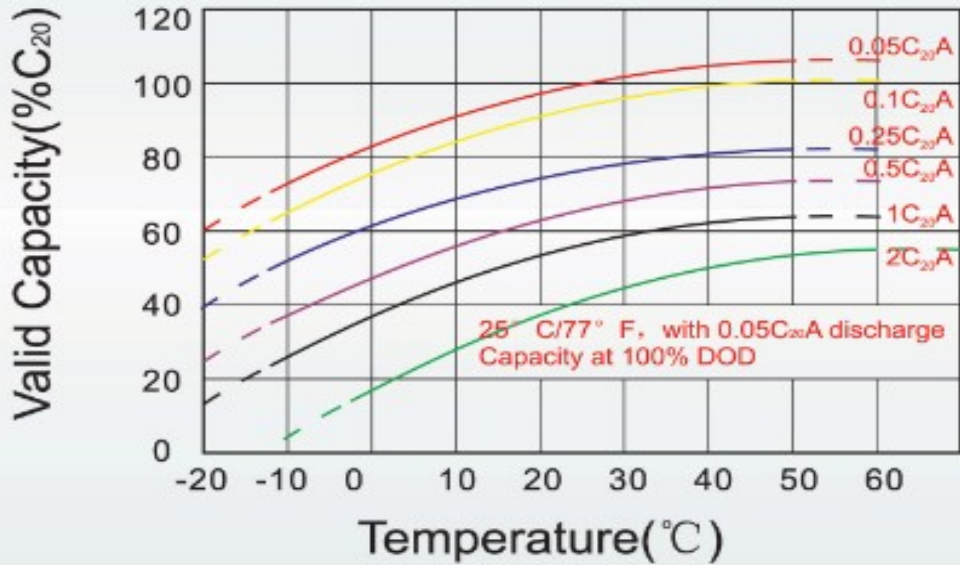

Charge Characteristics for Float Use @ 25°C/77°F

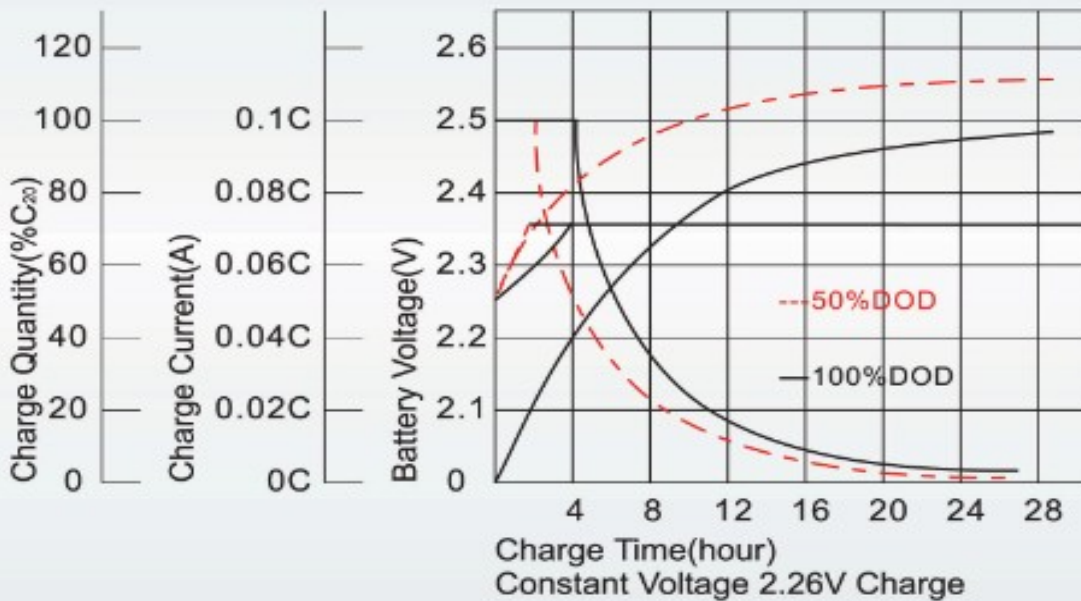



Sigma Power Systems

SG12350FP (12V 35.0Ah)

Discharge Characteristics at Various Rates @ 25°C/77°F

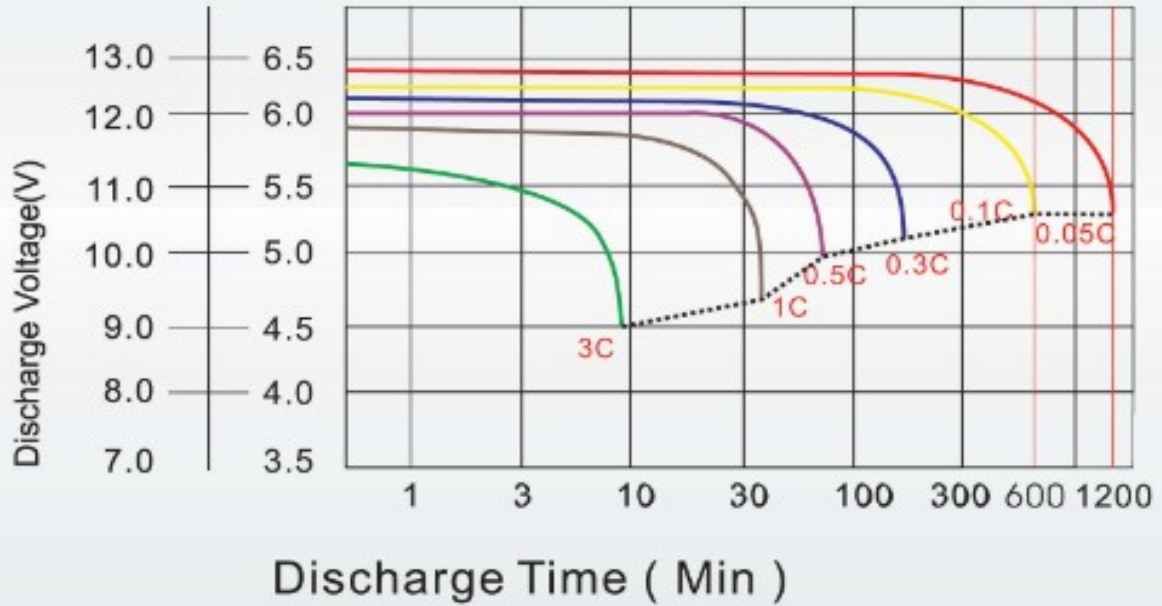

Cycle Life in Relation to Depth of Discharge

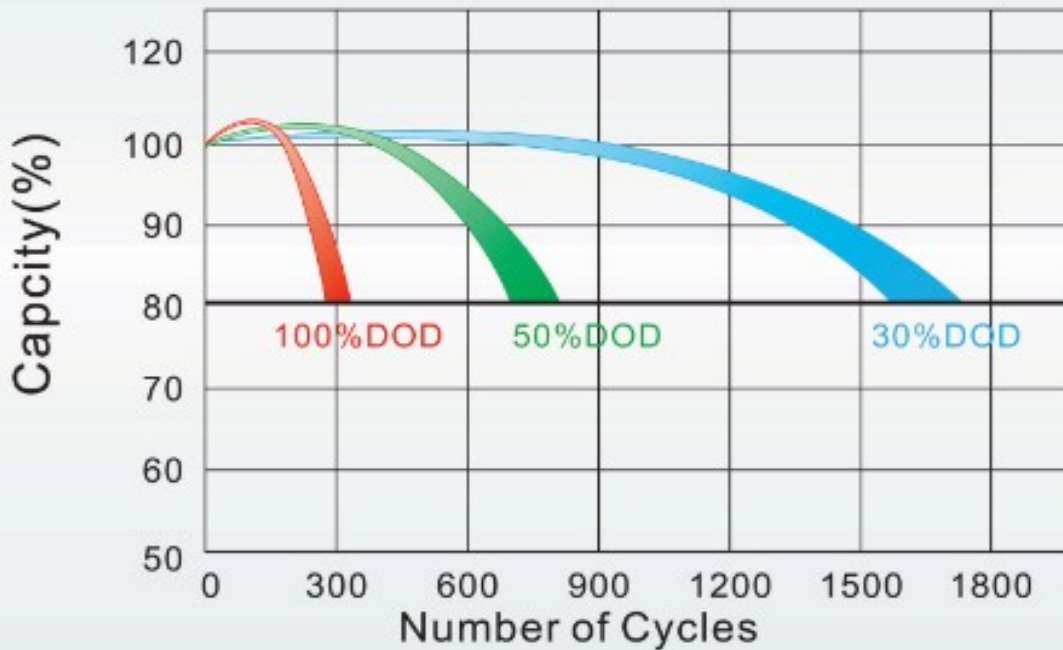



Sigma Power Systems

SG12350FP (12V 35.0Ah)

Capacity at Different Temperatures

Battery Type		-20°C	-10°C	0°C	5°C	10°C	20°C	25°C	30°C	40°C	45°C
GEL Battery	6V & 12V	50%	70%	83%	85%	90%	98%	100%	102%	104%	105%
	2V	60%	75%	85%	88%	92%	99%	100%	103%	105%	106%
AGM Battery	6V & 12V	46%	66%	76%	83%	90%	98%	100%	103%	107%	109%
	2V	55%	70%	80%	85%	92%	99%	100%	104%	108%	110%

Discharge Current Vs. Discharge Voltage

Final Discharge Voltage V/cell	1.75V	1.70V	1.60V
Discharge Current (A)	$A \leq 0.2C$	$0.2C \leq A \leq 1.0C$	$\geq 1.0C$

Safety & Maintenance Tips

- ⚠ Do not charge the battery in air tight atmosphere.
- ⚠ Do not short the terminals.
- ⚠ Avoid leaving them in hot environment.
- ⚠ Charge the batteries at least once in 6 months when the batteries are at 77F
- ⚠ Max. charge current 0.3CA, constant voltage 2.4-2.45V/Cell charge 24h
- ⚠ Effect of temperature on float charge voltage: -3mV/Cell.
- ⚠ Life will be reduced by number and depth of discharge.
- ⚠ Do not discharge below the minimum recommended voltage.
- ⚠ Leaving a discharged battery without charge for a long period of time will affect the life of the batteries.

Charging Method

Constant Voltage	$-0.2C * 2h + 2.4 - 2.45V/cell * 24h$, Max. Current 0.3CA
Constant Current	$-0.2C * 2h + 0.1CA * 12h$
Fast	$-0.2C * 2h + 0.3CA * 4.0h$

General applications – Emergency lights, solar, UPS, Alarm systems, Security systems, wheelchairs, flash lights, toys etc.

Charge the batteries at least once every six months, if they are stored at 25°C

www.sigmapowersystems.com



506 Business Pkwy,
Richardson, TX 75081
(877) 394-3941
info1@sigmapowersystems.com